

LED Surface Panel Round



Potenza

6W

Colore della luce



White
Light
(WH)

CE

RoHS

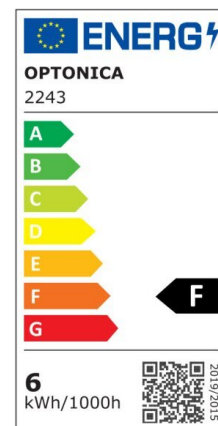
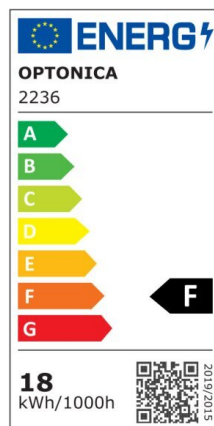
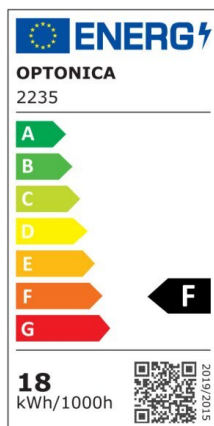
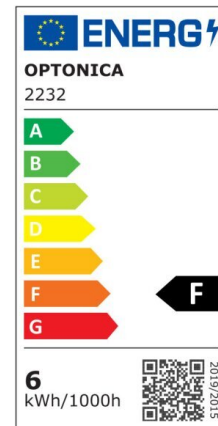
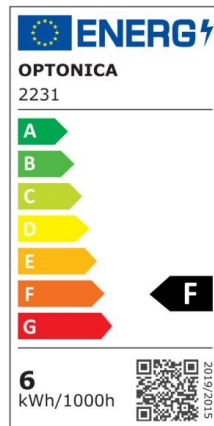
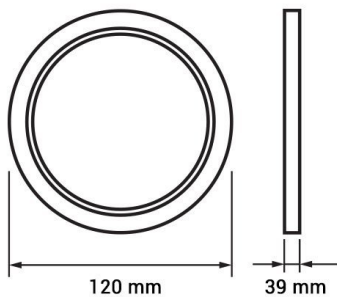

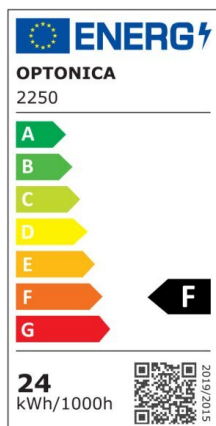
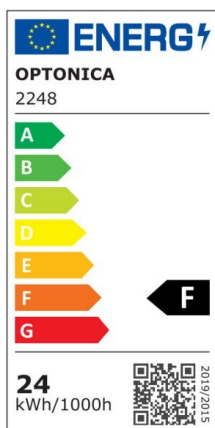
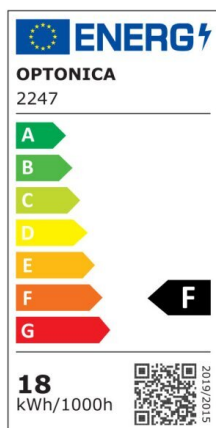
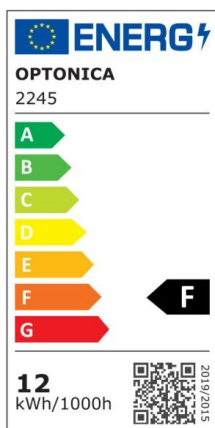
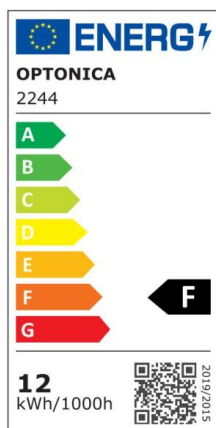

Specifiche tecniche

Numero di catalogo	2231
Angolo del fascio luminoso	120°
Marchio	Optonica
Codice Prodotto	DL6-A1
Codice Colore	860
Designazione del colore	White Light (WH)

Temperatura colore correlata	6000K
Dimmerabile	No
EAN Codice	3800156622319
Consumo energetico	6 kWh/1000h
Etichetta di efficienza energetica	F
Flux	480 lm
flusso per watt	80lm/W
Input voltage	AC180-260V
Instant On	0.2s
IP	20
Articoli per scatola	40
Articoli per confezione	1
Durata	25 000 Hours
Flusso luminoso residuo al termine del periodo di funzionamento	70%
Materiale	Aluminium
Cicli di accensione / spegnimento	25 000x
Frequenza operativa	50-60Hz
Potenza	6W
Power factor	0.5
LED di alimentazione	6W
Ra \geq	80
Dimensioni della scatola	420x270x285 mm
Dimensioni della confezione	130x125x41 mm
Dimensioni del prodotto	Φ 120x31 mm
Temperatura	-30°C / +50°C
Garanzia	2 Years

potenza equivalente	48W
Weight of Product	240 gr.